









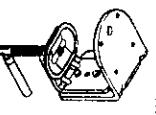

# Check - list

## Check List

01		X2	03		X2	06		X2
02		X2	04		X2	07		X4
			05		X12	08		X1
			11			09		X4
						10		X2
								X1

### Step 1

Adhere the pad to the clamp base.  
Desk thickness from 15mm~70mm.  
Then fix the clamp on the desk. If desk thickness over 70mm, please adjust screws with 5mm allen key. (as figure a.)

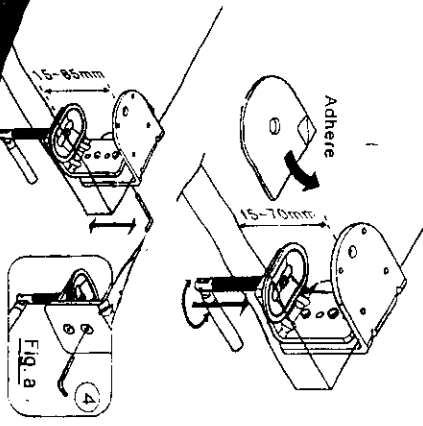

### Step 2

Use 4mm Allen key to secure the pole and clamp with 4 screws.  
Then put the plastic cover (06) through the pole and check the pin position with the screw together.

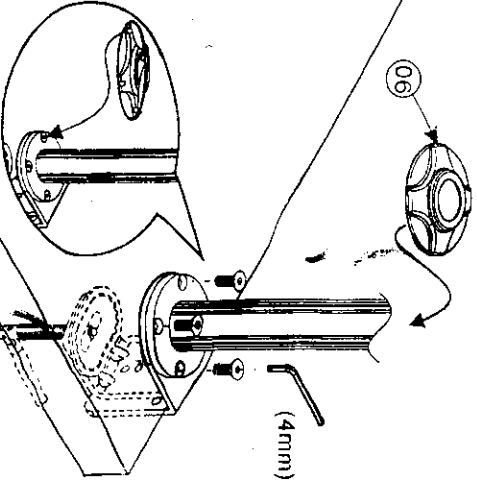

# Assembly guide

### Step 3

Follow the pole groove to put the spring. Please note the correct direction to set up the spring as figure F. Then set up the plastic cover on the top when you finish.

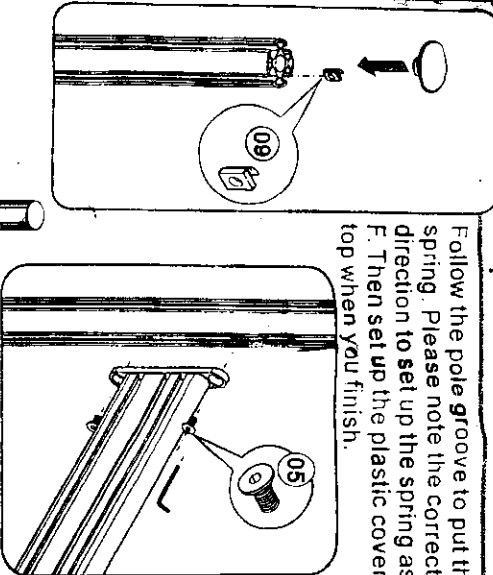

### Step 4

Take Partition to align the spring hole which already fixes on the pole. Then use 4mm Allen Key to secure the partition and pole together as figure.

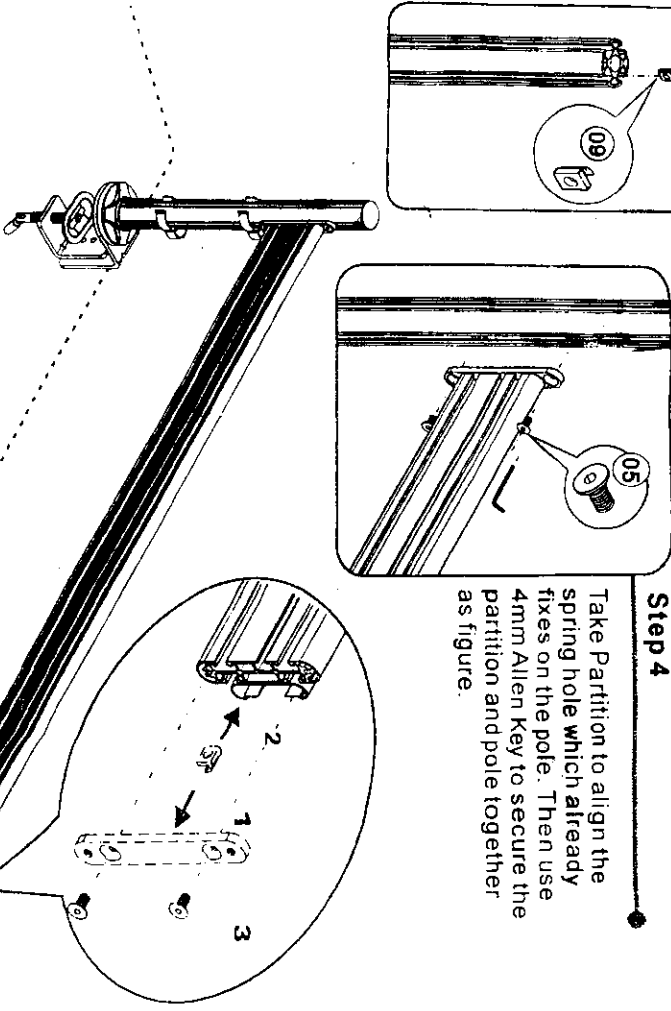

### Step 5

Please finish set up the cable management cover by few screws as figure after you set up LCD Monitor Arm.

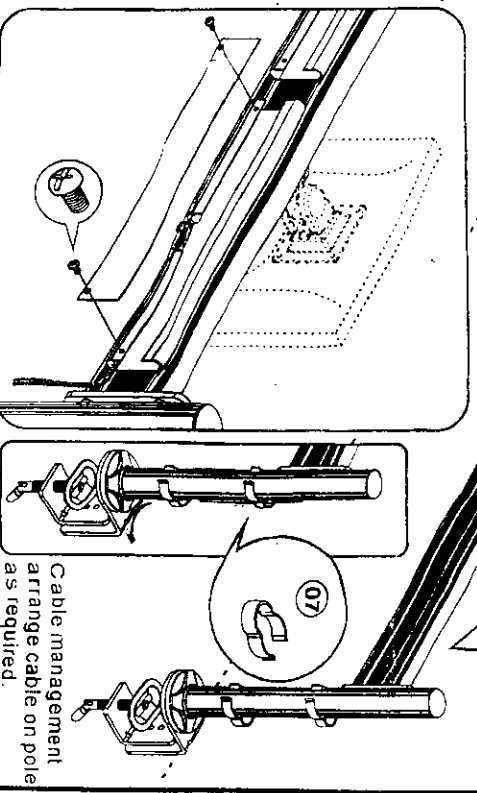

### Note:

For safety and artistry, please secured the cable management covers also in case you don't need the cable management function.